

Solely distributed by :



ATM Trading (M) Sdn. Bhd

A350



CargoMaster

Made in Germany



A350

Dimensional Sketch

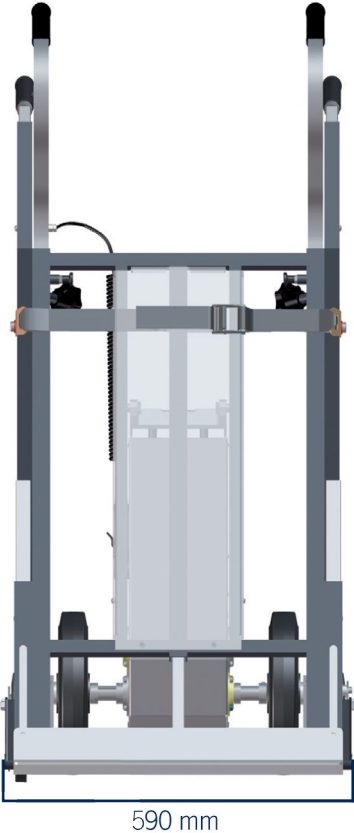

CargoMaster A350

Transport heavy loads safely upstairs and downstairs

To transport heavy loads up- and downstairs is one of the most difficult challenges of transportation. In most cases two people have to tackle the goods. Back and joints are unduly strained and accidents happen more easily — the CargoMaster relieves your back and your wallet.

The CargoMaster transports virtually all heavy goods over stairs with ease, speed, reliability and little physical power. Generally one person is sufficient to operate the device. The A350 is particularly suited to transport extremely heavy, wide and high goods. In such situations safety and stability are of the highest priority.

The A350 is our special device for really heavy goods. It transports loads up to 350 kg and is, therefore, ideal for heating boilers, copying machines, vending machines, slot machines, stoves, and much more.

Advantages that convince

- High maneuverability, even on narrow spiral stairs and landings
- Adjustable plate and grips to find the ideal center of gravity
- The range with the heaviest load lies at over 330 steps with one battery charge.





A350

350kg

No more anxiety before heavy tours / loads -

With the A350

For particularly tricky situations the A350 is equipped with a single step mode. The continuously adjustable speed helps to adjust the CargoMaster individually to any particular situation. The solid rubber puncture proof tires make the CargoMaster failsafe — even under long-term stress for the tires.

The powerful electric drive is provided with energy by an easily removable battery pack, out of reach for the competition in terms of range.



With the plate, adjustable in height, the center of gravity can also be adjusted.





Due to the grips, adjustable in height, and the adaptable plate, the A350 can be easily adjusted to the user's height and the respective situation of transportation.

Thus, even very high goods can be transported. On level ground you can also use the CargoMaster like a pushcart.

With inserted grips and folded plate, the A350 has a pack size of 1190 x 590 x 520 mm, and thus fits easily into even small vehicles of transportation.

CargoMaster A350 can be parked on the stairs. Also pushing on level ground is possible in this position without great physical effort. A350 can be parked on the stairs. Also goods. pushing on level ground is possible in this position without great physical effort.

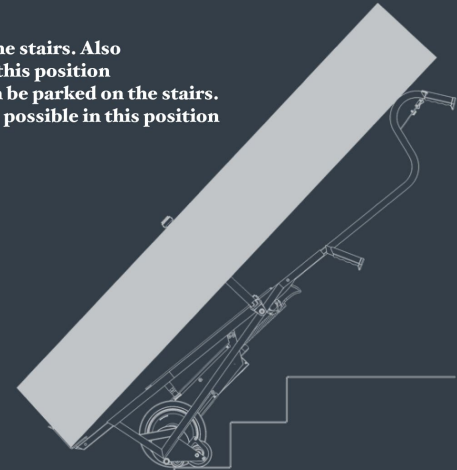
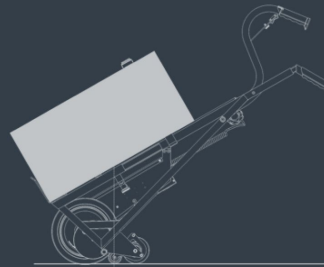

Depending on the goods and the center of the gravity, the A350 is also suitable to transport very high goods. It is also suitable to transport very high CargoMaster goods.

Also suitable to transport very high goods.



The CargoMaster A350 owes its high maneuverability on narrow stairs or landings to its low wheelbase and its innovative brake system. Changing position on the stairs is thus possible at all times.

When before two persons were necessary to carry something, the CargoMaster climbs and descends effortlessly upstairs and downstairs operated by one user only.



High ground clearance.



Continuously adjustable climbing speed.

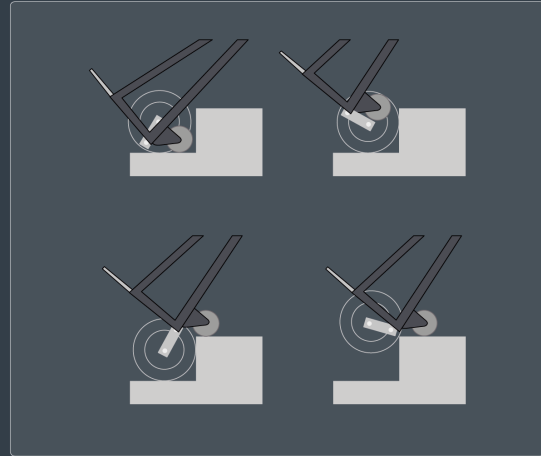

*** The stair climber for professionals relieves your employees' health and cuts down on personnel because with the stair climber in most cases one person is sufficient for operation. So the device quickly pays for itself.**



More information and videos, see www.cargomaster.org

Standard Equipment

The delivery package includes:

- One stair climber (A350) with standard plate (12cm)
- Battery pack
- Charger
- Lashing strap

The stair climber A350 comes in two colours;
you have a choice of either grey or orange.



Intelligent accessories —

For all situations of transportation

Item number	A142			A350			
Transportation wheel	-			100529			
Vertical lift	-			100399			
Auxiliary stairs	Steps	3 steps	4 steps	5 steps	3 steps	4 steps	5 steps
	Regular support	100017	100018	100126	100017	100018	100126
	Extended support	100325	100326	100522	100325	100326	100522
Stairs for extremely heavy goods	Extended support	104089	104004	104118	104089	104004	104118



Auxiliary stairs, made of steel, takes a load of up to 350 kg

Thanks to these stairs your transporter or delivery vehicle can easily be loaded and unloaded with the CargoMaster. Trunk sills between 480 – 900 mm in height are possible. If your vehicle sports a tow-bar, you need auxiliary stairs with the extended support.



Auxiliary stairs for very heavy goods with extended support, made of steel, takes a load of up to 500 kg.

Suitable for the transportation of very heavy goods.



Transportation wheel

With this transportation wheel loads can be pushed on level ground with very little physical effort. Thus, very quickly you can switch from stair climbing to wheeling goods on level ground. Also, higher goods can be transported through doors that way.



Battery pack

Additional battery pack for continuous operation.



Charger

Additional charger.



Charging cable for the car

Available in 12 V or 24 V.

Item number	Battery pack	Charger	Charging cable for the car		Supporting bow	Support for round containers	Back wall		Platform	
			12 V	24 V			Teppich	Gummi	Filtz	Gummi
A142	100020	100027	100022	100024	100019	100010	100074	100203	100006	100149
A350	100020	100027	100022	100024	100075	100010	100234	100204	-	

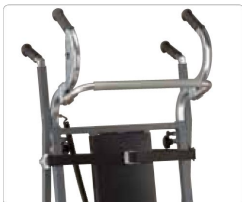

Supporting bow

This is suitable to transport high goods. Easy assembly due to gripper clamps on the bars of the grips. This helps to optimize the load's center of gravity for easy handling.



Support for round containers

Support for round containers with a diameter of 150 – 800 mm. Easy assembly by inserting.



Back wall

Protects the load from scratching or sliding through. Available with a rubber or felt cover.



Plattform

For special horizontal transportation. Available with rubber or felt cover.

Vertical lift (manual)

This vertical lift is simply attached to the CargoMaster A350. This way you can lift goods of up to 350 kg up or down from shelves, etc. With a crank handle the load is lifted up to the desired height (maximum of 65 cm). This lift is ideal, e.g. for stove makers.

A350

A350



Range of toe plates

CargoMaster A350

The toe plates of the A350 are adjustable in height. Please choose the appropriate plate for your particular situation of transportation from our wide range of plates.

Toe plate		Standard, 12 cm		25 cm	
Beams		regular *)	extended **)	regular	extended **)
Item number	instead of the standard plate	-	100153	100008	100206
	additional	100308	100298	100009	100205

Standard, 12 cm - regular beams

550 x 119 x 464 mm

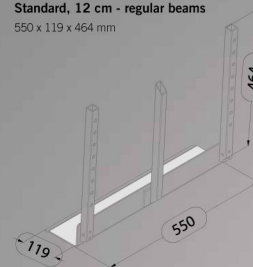

25 cm - Extended beams

550 x 249 x 464 mm

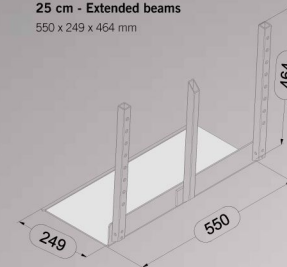

Standard, 12 cm - Extended beams

550 x 119 x 644 mm

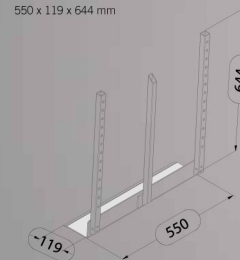

25 cm - Extended beams

550 x 249 x 644 mm

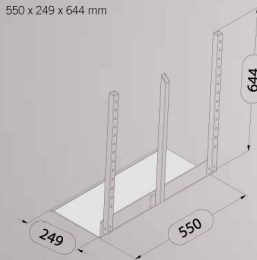

12

* Based on special requirements, we're more than happy to customize plates for your particular demands.



Toe plate for copying machines	Toe plate with rollers
regular	regular
100465	100528
100466	100527

Toe Plate for Copier Machine

Suitable for the transportation of copying machines. With the help of this particular plate the device can be inserted between the copier's rollers to take up the load more easily.

300 x 249 x 464 mm

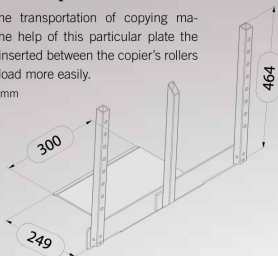

Toe plate with rollers

Equipped with two casters

550 x 249 x 464 mm

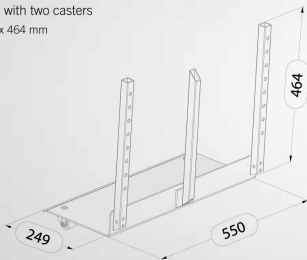

*) Included in the delivery package

**) The plate can be set lower because of the extended beams. This is particularly useful when transporting high goods in order to manipulate the center of gravity.

In addition, we are happy to produce special plates for your particular demands.

The Versatile Transportation Aid

Cargo Master Stair Climber

The Smart Solution

to Your

Transport problems



Call us to find out more information :

Tel: +603 - 7804 0018 / 012 - 7450900

Distributed by:

ATM TRADING (M) SDN BHD (331644-9)

NO.22A, Jalan PJU3/47, Sunway Technology Park, Sunway Damansara, 47810 Petaling Jaya, Selangor



DISTRIBUTED BY:

SAY GOODBYE
TO BACKACHES



ATM Trading (M) Sdn. Bhd

MOBILITY AT ITS BEST

Rehabilitation equipment made simple



S-MAX SELLA VARIO

1 DEVICE - 2 FUNCTIONS

UNIVERSAL WHEELCHAIR
ADD-ON KIT

CONTACT US FOR MORE INFORMATION:

Office Tel: 603-7804 0018

Product Assistant Specialist : 012-7450900

Email: sales@atm.com.my





ATM TRADING (M) SDN BHD
 NO.22, JLN PJU3/47,
 Sunway Technology Park,
 Sunway Damansara, 47810 Petaling Jaya
 Tel : 603-78053888 Fax : 603-78047106
 Website : www.atm.com.my

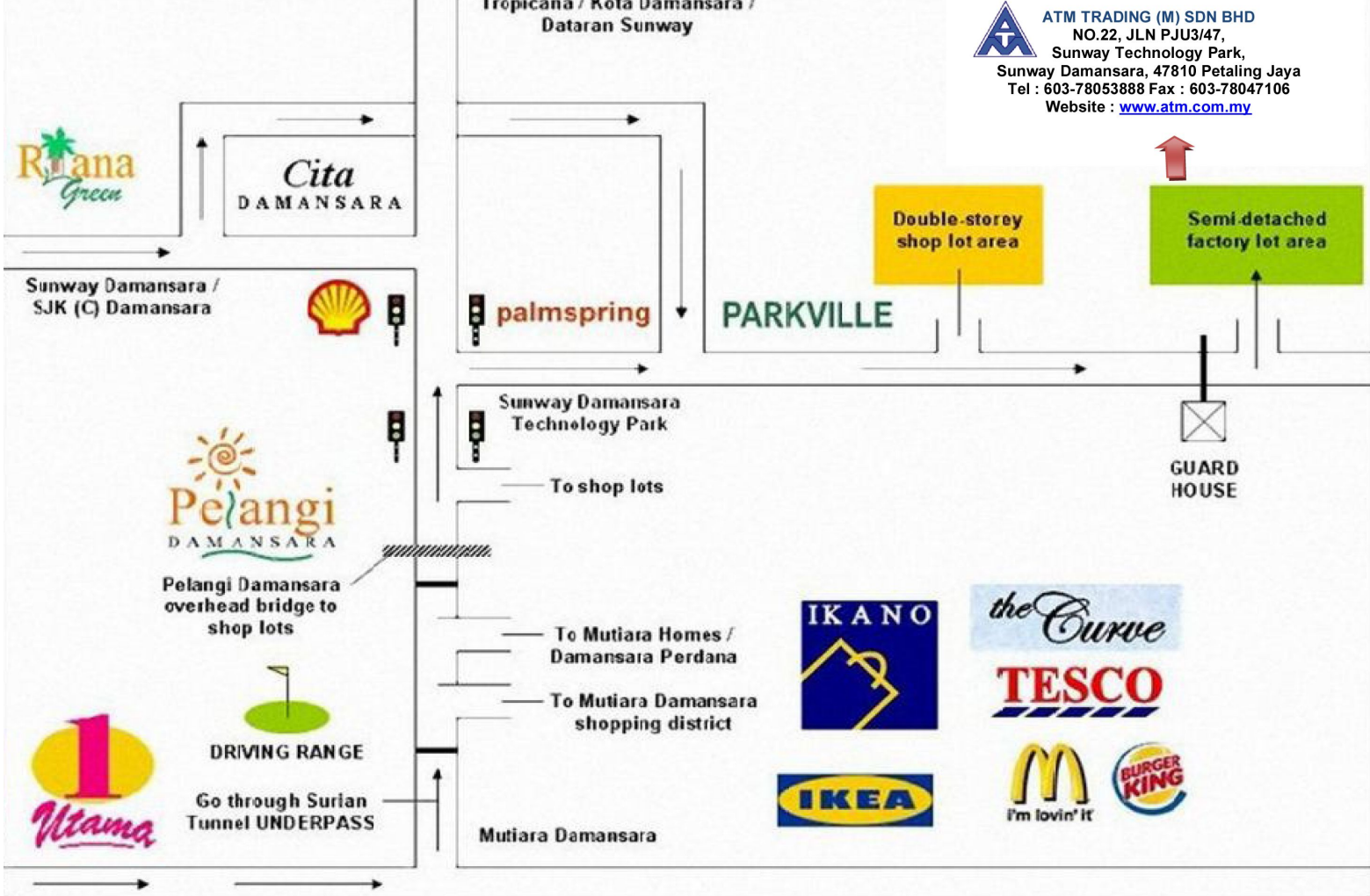

Taman Tun Dr. Ismail /
 Damansara Utama / Petaling Jaya

LEBUHRAYA DAMANSARA PUCHONG (LDP)

Kepong / Bandar Sri Damansara

Seals of quality and memberships



The company AAT Alber Antriebstechnik GmbH is a member on the BVS
Bundesverband des Sanitätsfachhandels e.V.



All products of the company AAT Alber Antriebstechnik GmbH has been tested
successfully by the Berlin Cert at the Technical University Berlin.



The company AAT Alber Antriebstechnik GmbH herewith declares that all products are developed
and produced according to the general regulations of the European guidelines 2007/47/EG.

CERTIFICATE



ISO 9001:2008

DEKRA Certification GmbH hereby certifies that the company
AAT Alber Antriebstechnik GmbH
Ehsetetter Weg 11, 72458 Albstadt, Germany

Scope of certification:

Development, production and sale of products in the rehabilitation-, transport- and medical technology market as well as service and repair

Certified locations:

D-72458 Albstadt, Ehsetetter Weg 11
D-72458 Albstadt, Zieglerstraße 7

has established and maintains a quality management system according to the above mentioned standard. The conformity was adduced with audit report no. 51143-Z4-00.

This certificate is valid from 2016-08-16 to 2018-09-14

Certificate registration no.: 40704918/5



Deutsche
Zertifizierungsstelle
D 574 50929-01-01

Lothar Wernhofen
DEKRA Certification GmbH Stuttgart; 2016-07-04

DEKRA Certification GmbH * Handwerkerstraße 15 * D-70565 Stuttgart * www.dekra-certification.de

CERTIFICATE



EN ISO 13485:2012 + AC:2012

DEKRA Certification GmbH hereby certifies that the company
AAT Alber Antriebstechnik GmbH
Ehnestetter Weg 11, 72458 Albstadt, Germany

Scope of certification:

Development, production and sale of products in the rehabilitation technology and emergency medicine as well as service and repair

Certified locations:

Ehnestetter Weg 11, 72458 Albstadt, Germany
Zieglerstraße 7, 72458 Albstadt, Germany

has established and maintains a quality management system according to the above mentioned standard. The conformity was adduced with audit report no. 51143-Z4-00.

This certificate is valid from 2016-08-16 to 2019-08-15

Certificate registration no.: 51143-11-01



DEKRA Certification GmbH Stuttgart, 2016-07-04

DEKRA Certification GmbH * Handwerksstraße 15 * D-70565 Stuttgart * www.dekra-certification.de



Deutsche
Akkreditierungsstelle
D-ZM-16029-08-00

The background is a solid dark blue color. In the upper left quadrant, there are several thin, white, curved lines that sweep across the frame, creating a sense of motion or a stylized graphic element.

CargoMaster

The Stair Climber for Professionals